



súprava B-2RV-ROS-DM



podnožka PN



B-2RM-ROH-2-B +PN



noha NR

noha FL

noha H1  
hranol 6x6cm

noha H2  
hranol 8x8cm

noha NV1  
valcová

noha KUZ  
kuželová

noha KON  
kónicka

# GENÉZA



## PRÍKLADY ZOSTÁV :

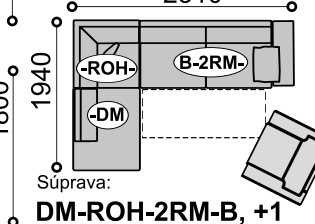
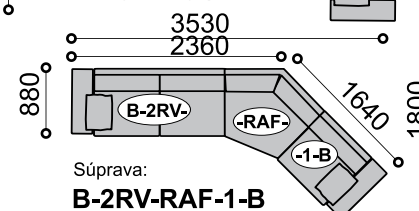
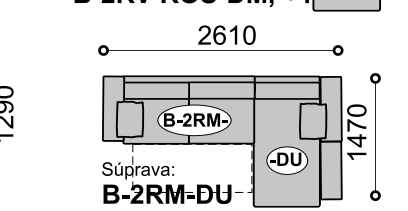
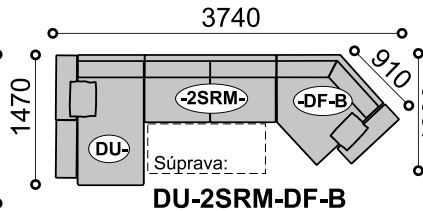
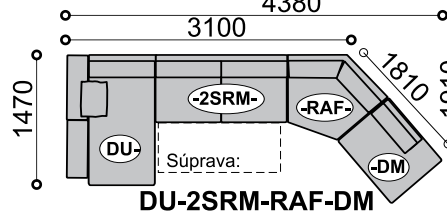
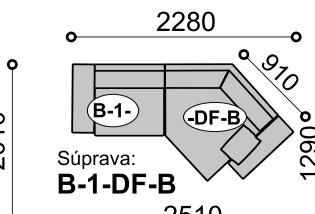
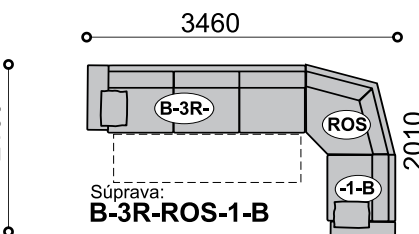
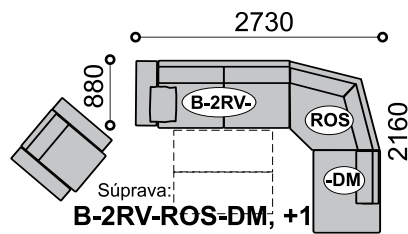
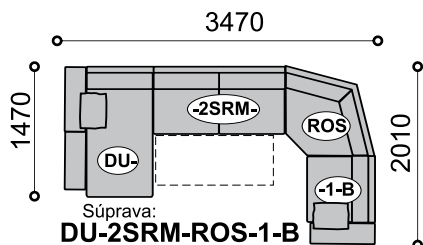
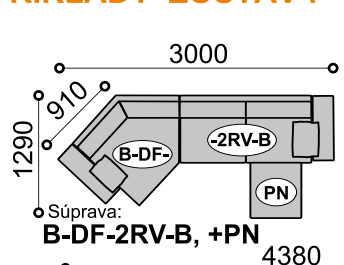

**ROZKLAD S MALÝM VOZÍKOM -2RSM-, B-2RM- JE URČENÝ DO PRAVOUHLYCH ROHOVÝCH ZOSTAV K ELEMENTOM: -DU, -ROH-DM, -ROH-1S-, -ROH-1-B, -ROH-2-B, -ROH-3S-, -ROH-3-B.**

# GENÉZA

1

2  
2R

3  
3R

B-1-

-1-B

B-2-  
B-2RV-

B-2RM-

-2-B  
-2RV-B

-2RM-B

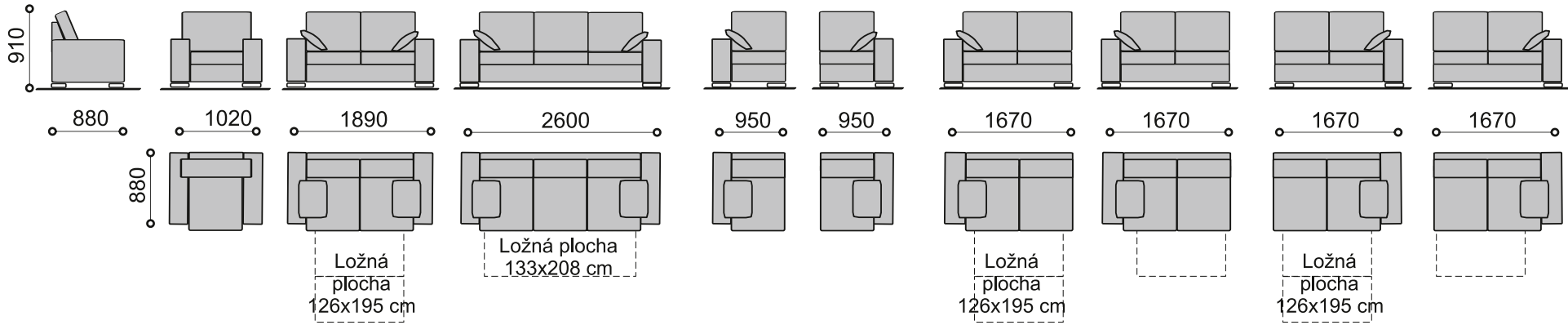

podhlavník



podnos

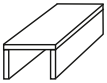

B-3-  
B-3R-

-3-B  
-3R-B

-1S-

-2S-  
-2SRV-

-2SRM-

-3S-  
-3SR-

-DM

DM-

P

PN

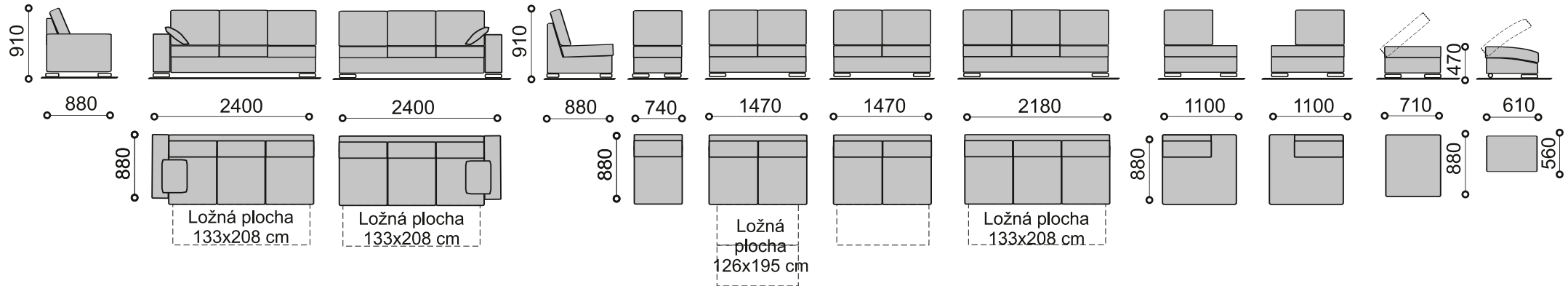

-ROS-

-RAF-

-ROH-

B-DF-

-DF-B

DF-

-DF

DU-

-DU

DRM-

-DRM

DRO-

-DRO

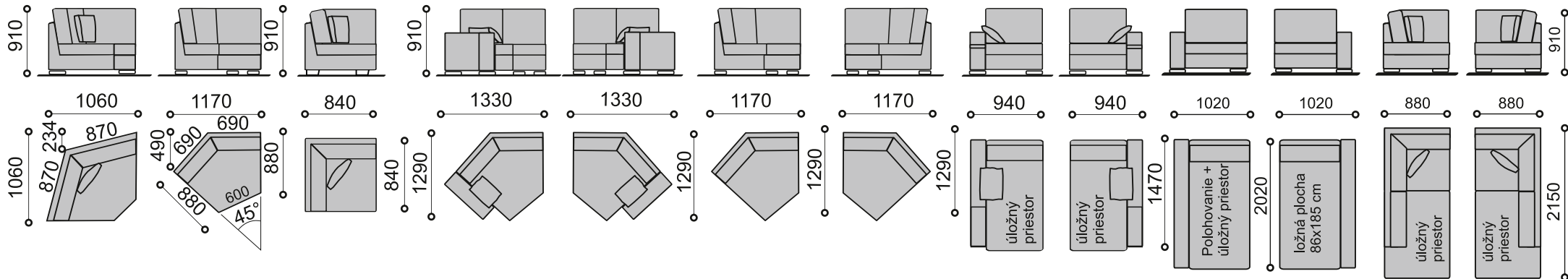

## Typový plán GENEZA

Model	Označenie	Šírka	Výška	Hĺbka	Funkcie
	<b>3R</b>	260	91	88	①
	<b>3</b>	260	91	88	
	<b>2R</b>	189	91	88	②
	<b>2</b>	189	91	88	
	<b>1</b>	102	91	88	
	<b>B-3R-</b>	240	91	88	①
	<b>B-3-</b>	240	91	88	
	<b>B-2RV-</b>	167	91	88	②
	<b>B-2RM-</b>	167	91	88	③
	<b>B-2-</b>	167	91	88	
	<b>B-1-</b>	95	91	88	
	<b>-3R-B</b>	240	91	88	①
	<b>-3-B</b>	240	91	88	
	<b>-2RV-B</b>	167	91	88	②
	<b>-2RM-B</b>	167	91	88	③
	<b>-2-B</b>	167	91	88	
	<b>-1-B</b>	95	91	88	
	<b>-3SR-</b>	218	91	88	①
	<b>-3S-</b>	218	91	88	
	<b>-2SRV-</b>	147	91	88	②
	<b>-2SRM-</b>	147	91	88	③
	<b>-2S-</b>	147	91	88	
	<b>-1S-</b>	74	91	88	
	<b>-DM</b>	112	91	88	
	<b>DM-</b>	112	91	88	
	<b>-DU</b>	94	91	147	④
	<b>DU-</b>	94	91	147	④
	<b>-DRM</b>	102	91	202	④⑤
	<b>DRM-</b>	102	91	202	④⑤

Model	Označenie	Šírka	Výška	Hĺbka	Funkcie
	<b>DRO-</b>	88	91	215	⑥
	<b>-DRO</b>	88	91	215	⑥
	<b>-ROH-</b>	84	91	84	
	<b>-ROS-</b>	106	91	106	
	<b>-RAF-</b>	117	91	112	
	<b>B-DF-</b>	133	91	129	
	<b>-DF-B</b>	133	91	129	
	<b>DF-</b>	117	91	129	
	<b>-DF</b>	117	91	129	
	<b>P</b>	71	47	88	⑦
	<b>PN</b>	61	47	56	⑧
<b>Doplňky :</b>					
					podnos

### Príklady súprav :

	<b>B-2RV-ROS-DM</b>	273	86	218	②
	<b>DU-2SRM-DF-B</b>	374	86	147	③④
	<b>B-2RV-RAF-1-B</b>	353	86	180	②
	<b>B-2RM-DU</b>	261	86	147	③④
	<b>DRM-2SRM-RAF-DM</b>	446	86	202	③④⑤
	<b>DRO-3R-B</b>	328	86	215	①⑥

### V modeloch sú zainštalované funkcie :

