



SARAH

bok č. 1

súprava SARAH B-3Rv-VROH-1-PT s vľahmi na opierkach .

Sarah a Sabrina je komfortná sedacia súprava rozkladacia s úložným priestorom, s variabilitou zostáv z 38 elementov. SARAH súprava má čalúnenie na opierkách s vľahmi a súprava SABRINA má čalúnenie opierok bez vľahov. Pohodlné sedenie zabezpečujú kvalitné vysokoelastické PUR peny a vlnité pružiny v sedáku. Nohy plastové výšky 45mm. Úložný priestor je v 2-kreslách a v taburetke Tab. Rozkladanie majú 3-kreslá, plocha na spanie v sólo 3R-kresle 130x185cm(v- rozklad), v rohovej zostave 120x200cm(m- rozklad), v U-zostave 120x273cm(m- rozklad), v zostavách s VROH-om a s 3-kreslom, kde nie je možné použiť m- rozklad je plocha na spanie 130x185cm(v- rozklad).



Ponuka nôh do súpravy v odtieňoch: (taburetka Tab nemá nohy, ale klzáký 1cm vysoké)



HST - šedá



HSH - hnedá



HSJ - jelša



HSK - buk



HSB - čierna



bok č. 1



bok č. 2



SABRINA

súprava SABRINA B-2u-ROH-3SRHm-DU bez vľahu na opierkach .



bok č. 1



bok č. 2



súprava B-2u-ROH-3SRHm-DU s vľahmi na opierkach .



Tab



VT



Vlnité pružiny



Sendvičový molitán v sedáku



Rozkladanie



Úložný priestor

SARAH, SABRINA s bokom č.1

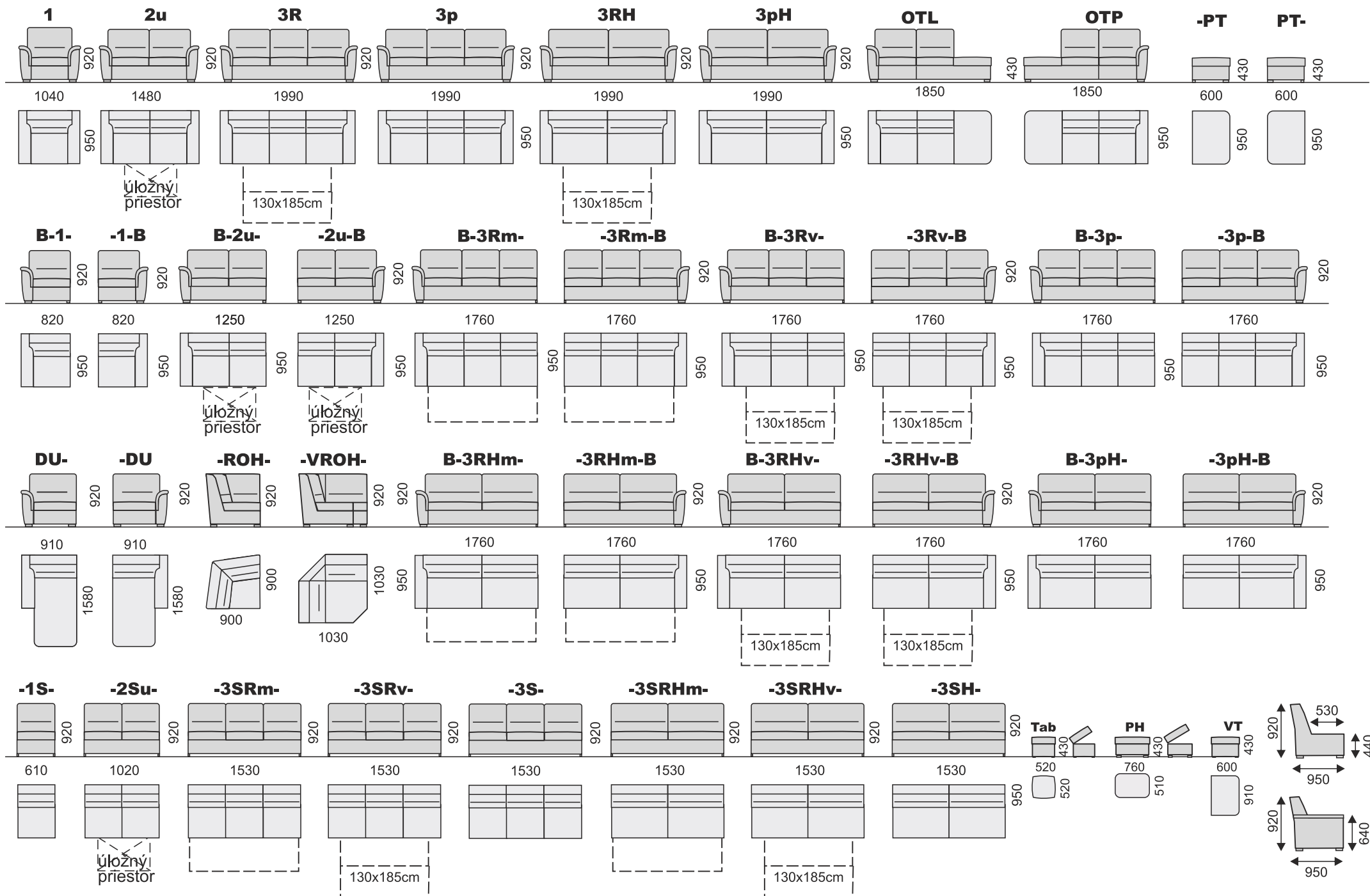

SARAH , SABRINA s bokmi č.1 :



Príklady zostav :

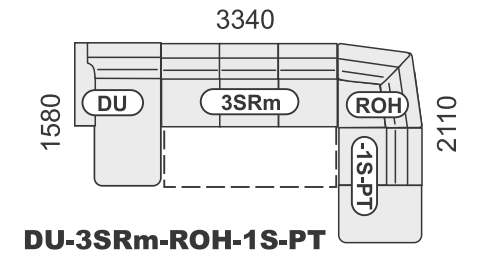
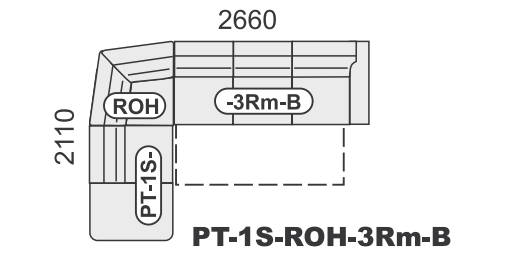
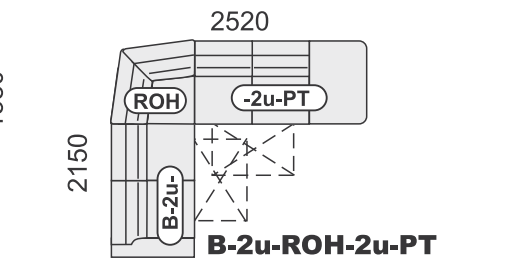
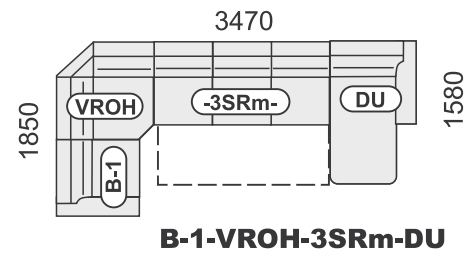
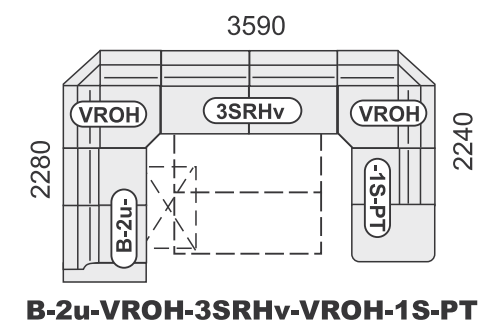
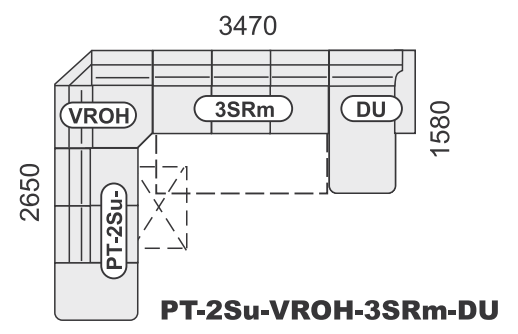
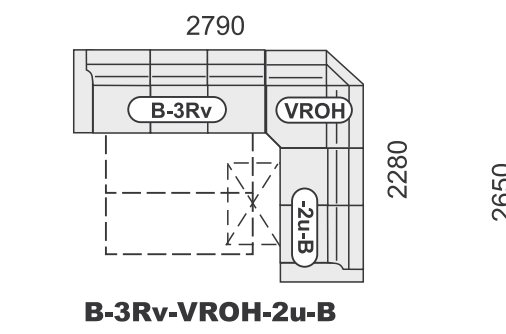
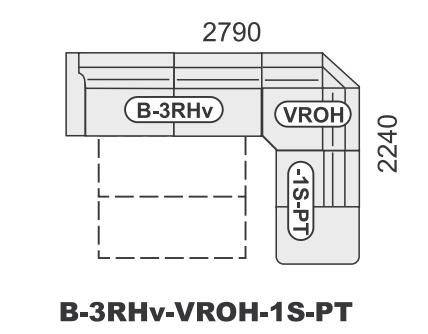
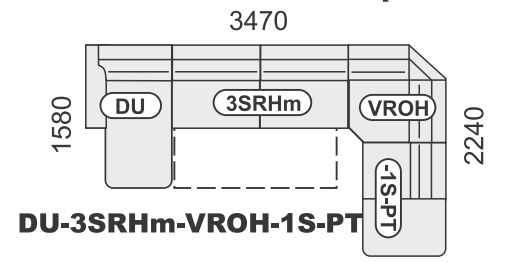
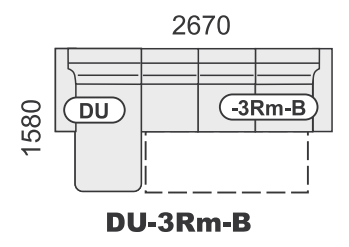
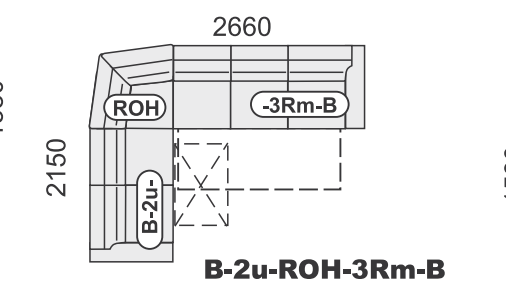
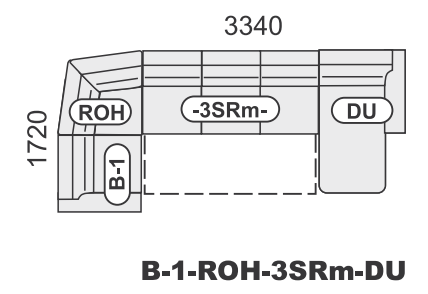
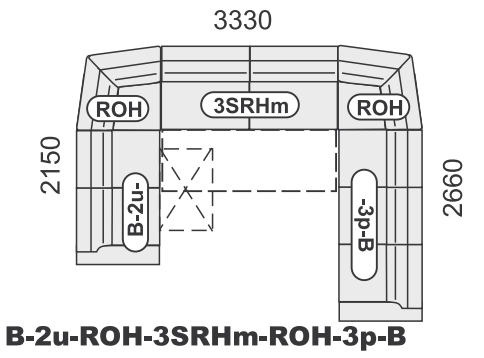
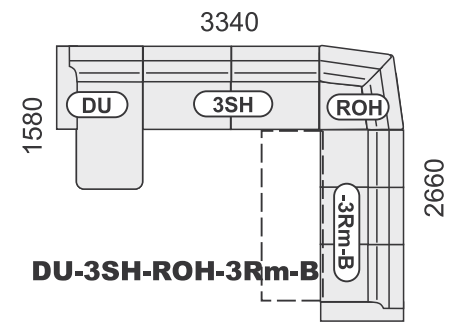
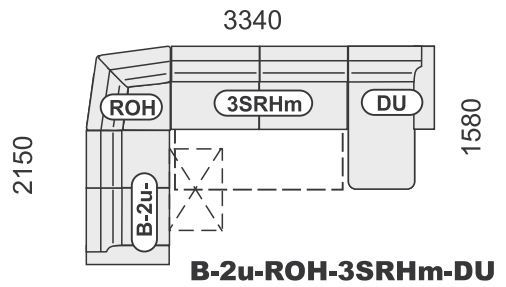
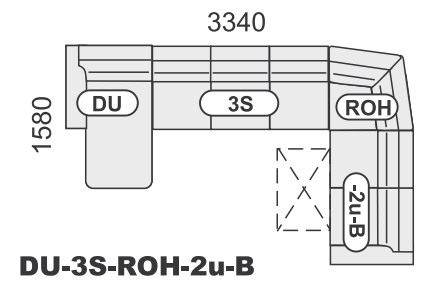

SARAH, SABRINA s bokom č.2

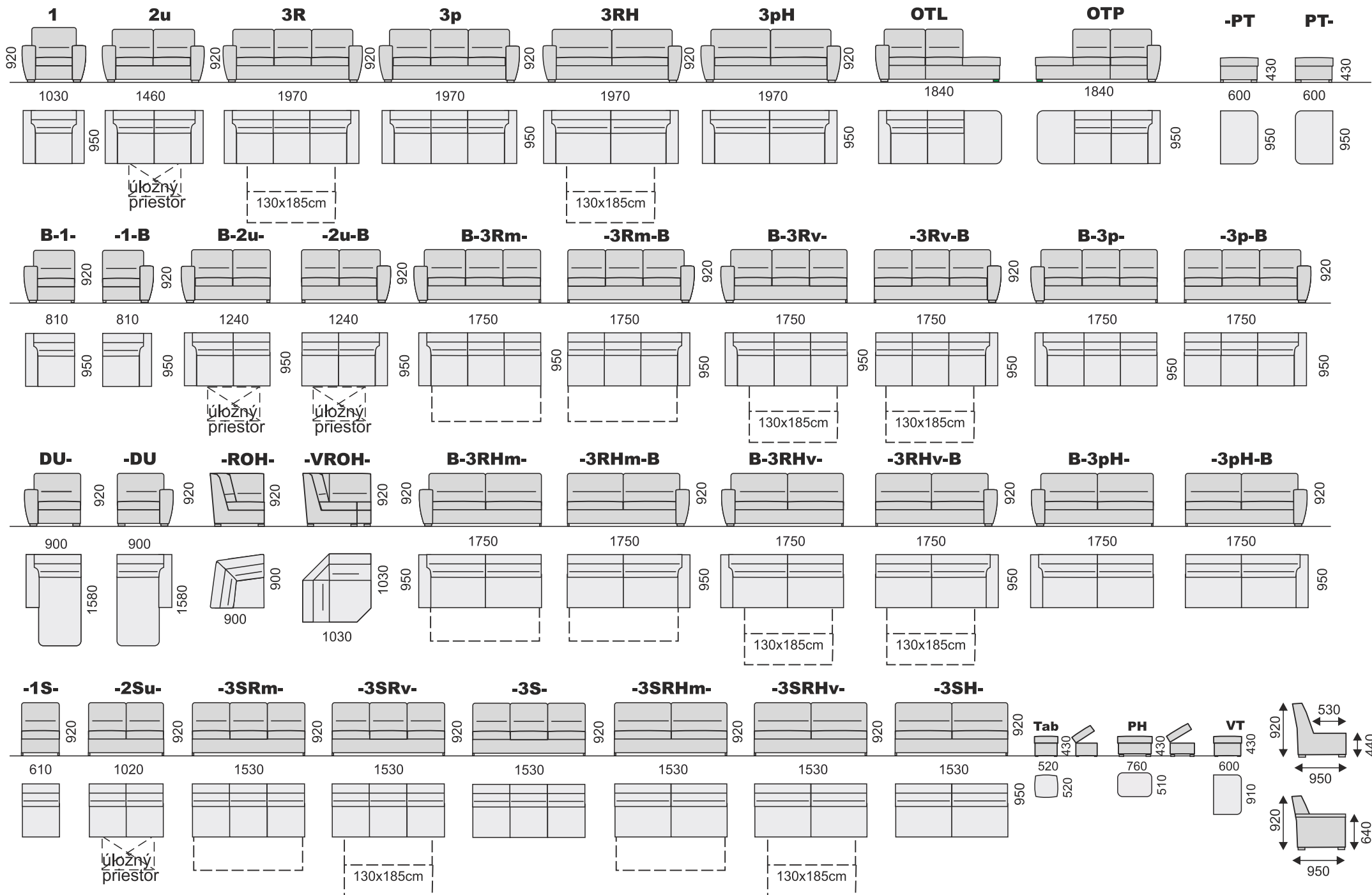

SARAH , SABRINA s bokmi č.2 :



Príklady zostav :

